

Scriptroute: A facility for distributed Internet measurement

www.scriptroute.org

Neil Spring, David Wetherall, and Tom Anderson

University of Washington

NANOG 26

Network Measurements are Painful

Everyone measures the network

Network measurement is hard

- Development - arcane interfaces, need root.
- Infrastructure - distributed tools are harder.

Scriptroute is an environment for distributed
lightweight network measurements

- Development simplified - scripted measurements.
- 33 sites ready to execute new measurements.

Ideal Net Measurement Platform

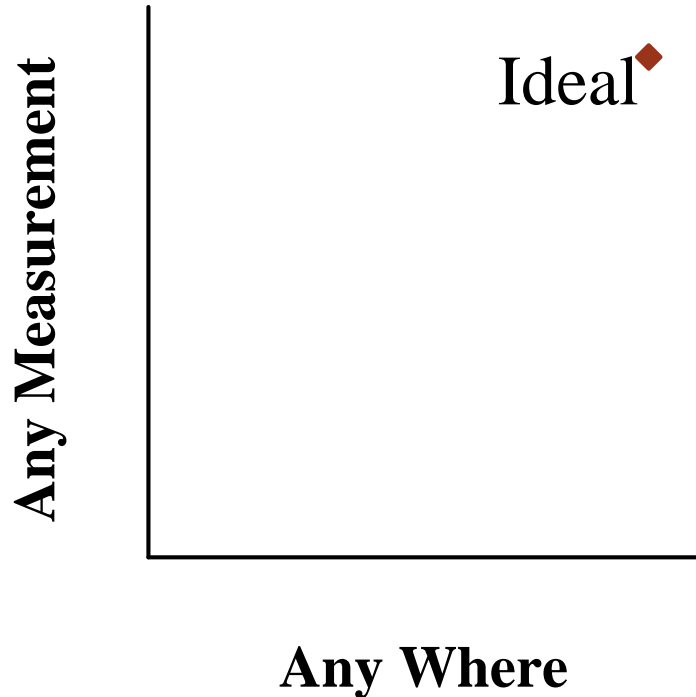

1. Any network measurement
 - Connectivity, performance
 - Topology, routing
2. From any host
 - Vantage points
 - Comprehensive coverage for debugging

Can't get there, but how close can we get?

Dedicated Testbeds

NIMI, RIPE NCC, AMP, etc.

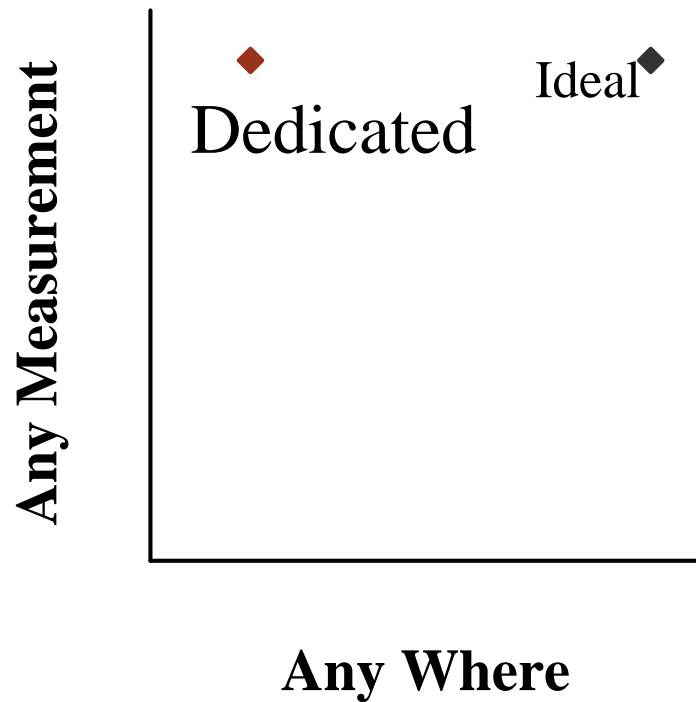

1. Just about any measurement.
2. Dedicated machines
 - Uniform hardware and software image
 - Special hardware for timestamping

Great flexibility, inherently limited deployment.

Public Traceroute Servers

1. Just traceroute and ping.

2. Lots of servers, even routers via web gateways.

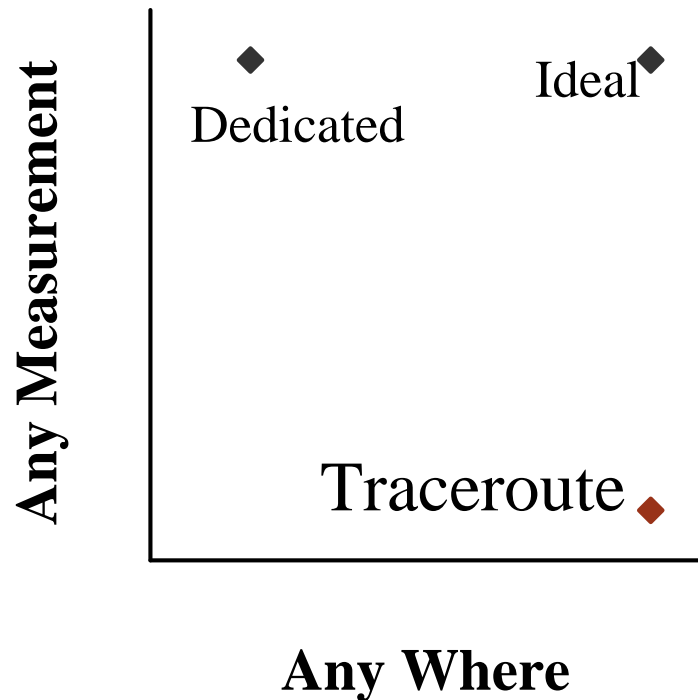

Open system:

- Provides service to any client.
- Anyone can run a server.

Wide deployment, inherently limited flexibility.

Scriptroute: Flexible measurement

1. Support measurements with:

- Few packets, bytes
- Safe packets
- Little resources

2. On shared, ordinary servers

- Interpreter is the environment

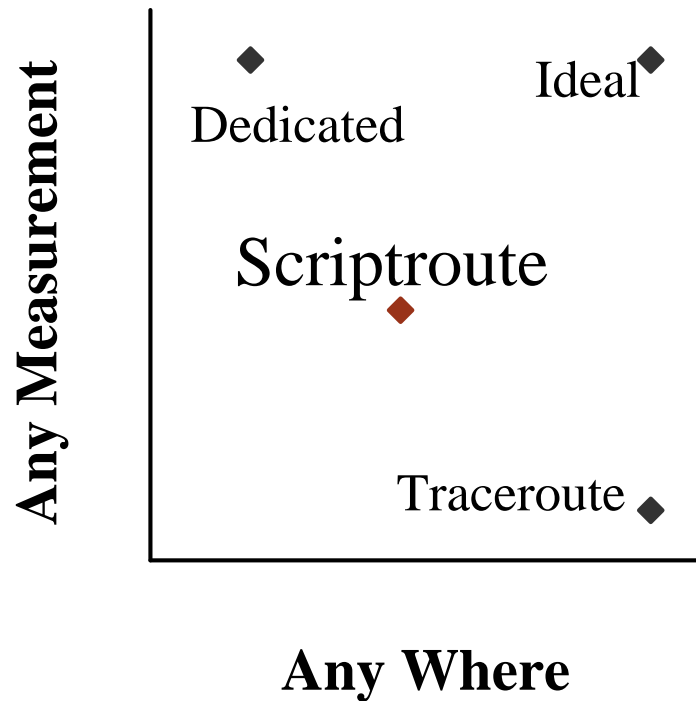

Combine the best attributes of both systems.

What we've used it for

Small tools:

traceroute, tcptraceroute: Router paths (25 lines)

ping: 1 second or Poisson intervals (27 lines)

ally: Group interface addresses to routers (90 lines)

sprobe: Packet-pair bandwidth estimation (63 lines)

Distributed tools:

GNP Evaluation: Ping 8,000 hosts from 33 servers to test a host distance estimation scheme. (90 lines)

Reverse Path Tree: Build a tree of paths taken from all servers to an address. (340 lines)

Reverse path tree (whole)

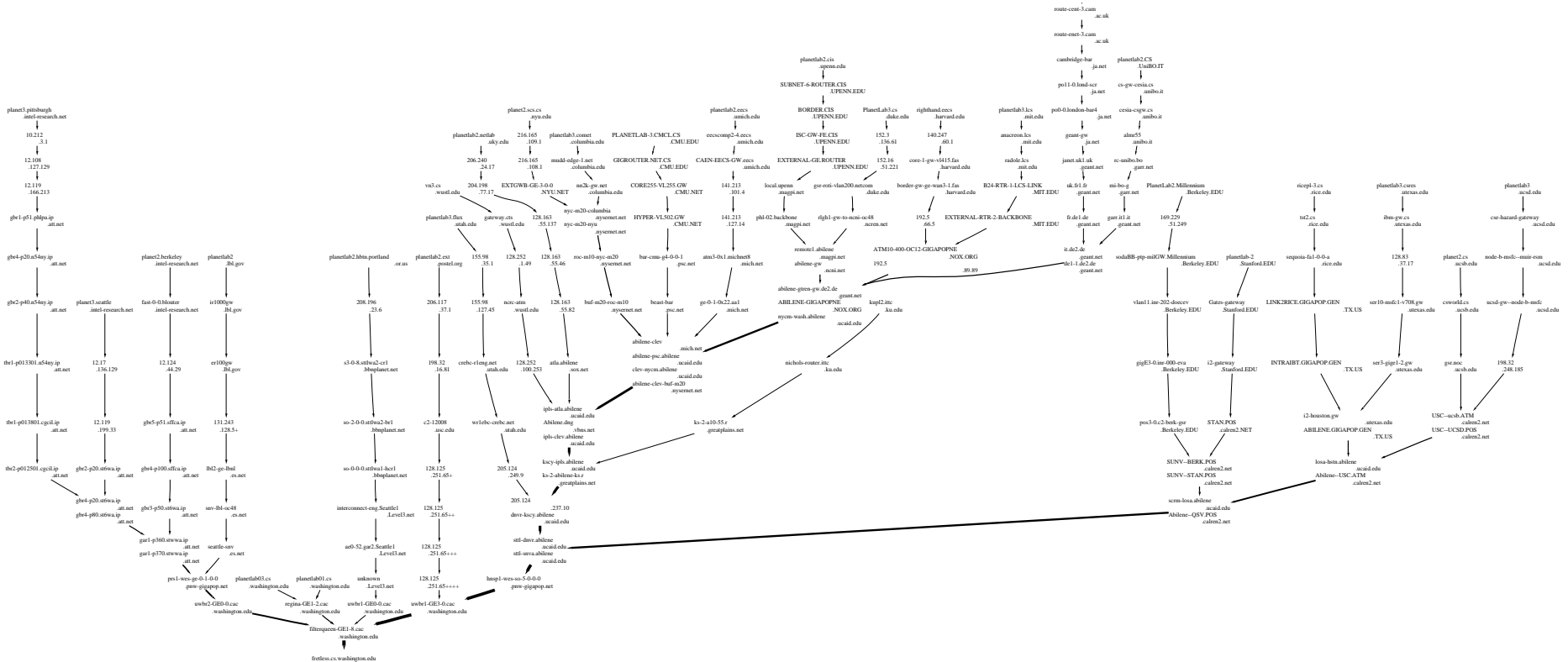

Traceroute +: Alias resolution merges IP addresses to routers.

Network friendly: Doesn't retrace hops, lookup names.

Reverse path tree (zoomed)

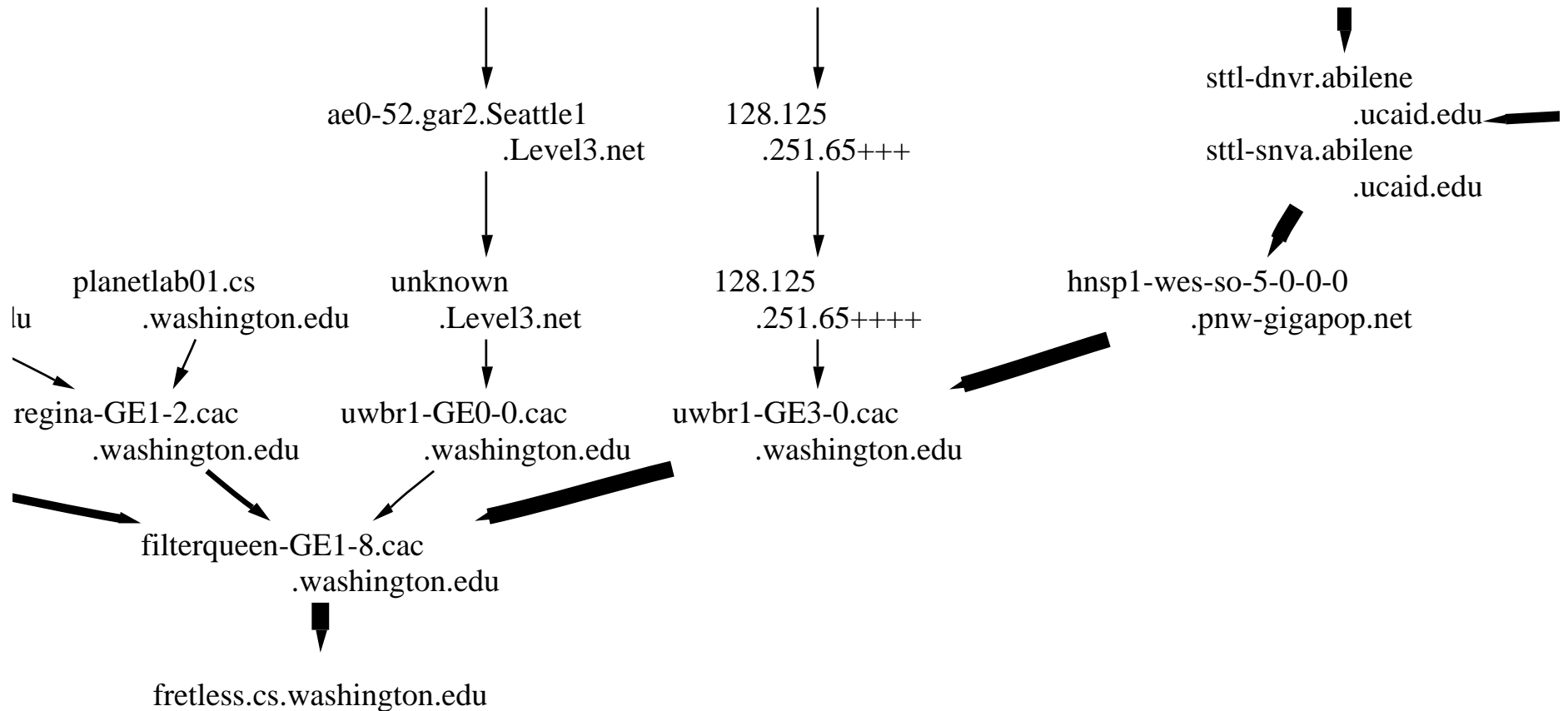

Line thickness \approx servers sharing the link.

sttl-dnva and sttl-snva are aliases listed together.

Reverse path tree summary

Efficient:

- Name lookups at the client
- Tree not retraced; One probe per hop
- 195 traceroute packets instead of 975.
- 1.5 minutes tracing, 2.5 minutes alias resolution.

Foundation for future tools:

- Annotate with link properties, e.g., latency.
- Group by service provider, render on a world map.
- Find servers that share paths.

Scriptroute architecture

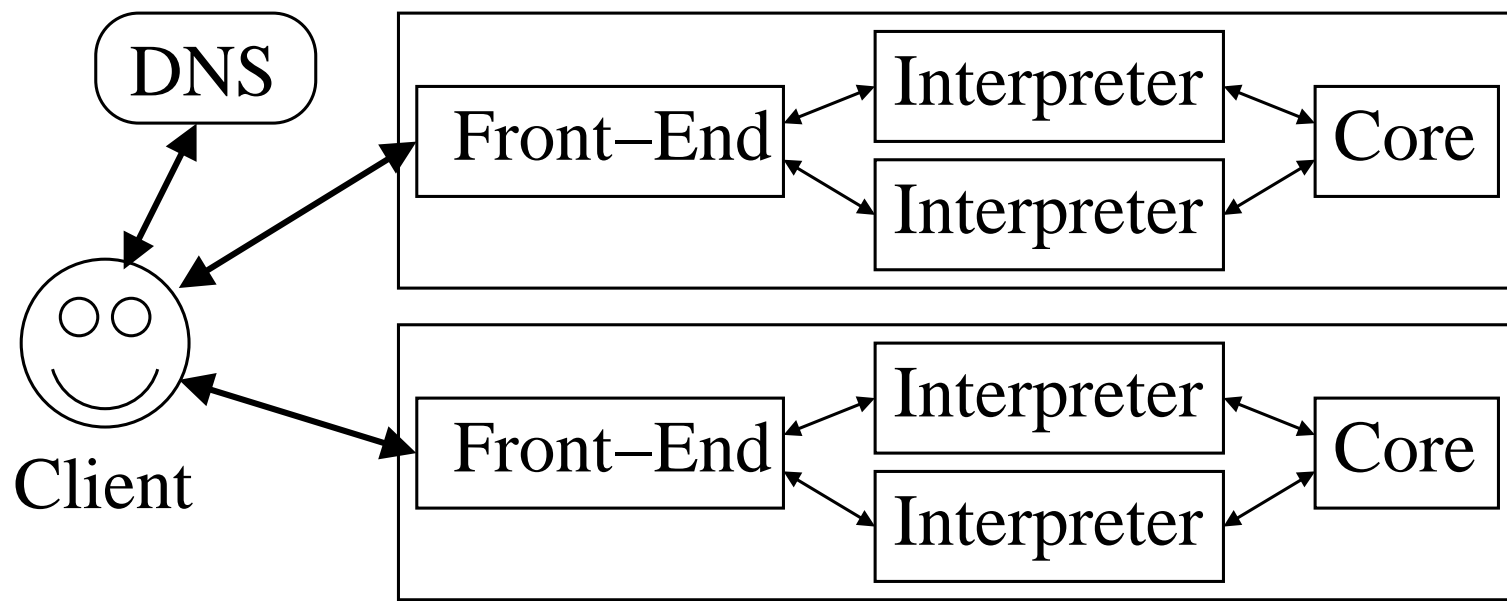

DNS: Lists active servers by AS, country

Front-End: Web server on port 3355

Interpreter: Resource limited, sandboxed execution

Core: Provides, restricts access to the network

Scriptroute scripts

Measurement scripts are expressed in Ruby:

- Object-oriented, type-safe, general-purpose
- Safe mode prevents system calls

Interpreter enhanced with:

- `send_train()` sends probes, collects responses
- Packet types, constants
- Transparent `hton[ls]()`, `inet_aton()`.

Core deals with checksums and matching responses.

Traceroute for Scriptroute

```
#!/usr/bin/srinterpreter
probe = Scriptroute::Udp.new(12)
probe.ip_dst = ARGV[0]
port_unreach = false
catch (:port_unreachable) do
  ( 1..64 ).each { |ttl|
    ( 1..3 ).each { |rep|
      probe.ip_ttl = ttl
      pkts = Scriptroute::send_train([ Struct::DelayedPacket.new(0,probe) ])
      resp = (pkts[0].response) ? pkts[0].response.packet : nil
      rtt = (resp) ? ((pkts[0].response.time - pkts[0].probe.time) * 1000.0) : '*'
      if(resp.is_a?(Scriptroute::Icmp)) then
        puts ttl.to_s + ' ' + resp.ip_src + ' ' + rtt.to_s + ' ms'
        port_unreach = true if(resp.icmp_type == 3 && resp.icmp_code == 3)
      end
    }
  }
  throw :port_unreachable if(port_unreach)
}
end
```

TCP-Traceroute

```
#!/usr/bin/srinterpreter
probe = Scriptroute::Tcp.new(0)
probe.ip_dst = ARGV[0]; tcp_rst = false
catch (:tcp_rst) do
  ( 1 .. 64 ).each { |ttl| ( 1 .. 3 ).each { |rep|
    probe.ip_ttl = ttl
    pkts = Scriptroute::send_train([ Struct::DelayedPacket.new(0,probe) ])
    resp = (pkts[0].response) ? pkts[0].response.packet : nil
    rtt = (resp) ? ((pkts[0].response.time - pkts[0].probe.time) * 1000.0) : '*'
    if(resp.is_a?(Scriptroute::Icmp)) then
      puts ttl.to_s + ' ' + resp.ip_src + ' ' + rtt.to_s + ' ms'
    elsif(resp.is_a?(Scriptroute::Tcp)) then
      puts ttl.to_s + ' ' + resp.ip_src + ' ' + rtt.to_s + ' ms'
      tcp_rst = true
    end
  }
  throw :tcp_rst if(tcp_rst)
}
end
```

Security model: Open but restricted

Protecting Scriptroute hosts:

- Safe mode interpreter as nobody in a chroot
- Kernel resource limits
- Duration and number of scripts limited

Protecting the network and remote hosts

- Byte, packet, and SYN rate limits
- Filter bad traffic, eg. broadcast, fragments
- Destination-specific filter repository
- Logging prevents anonymous reflection

Finding servers

73.as.servers.scriptroute.org

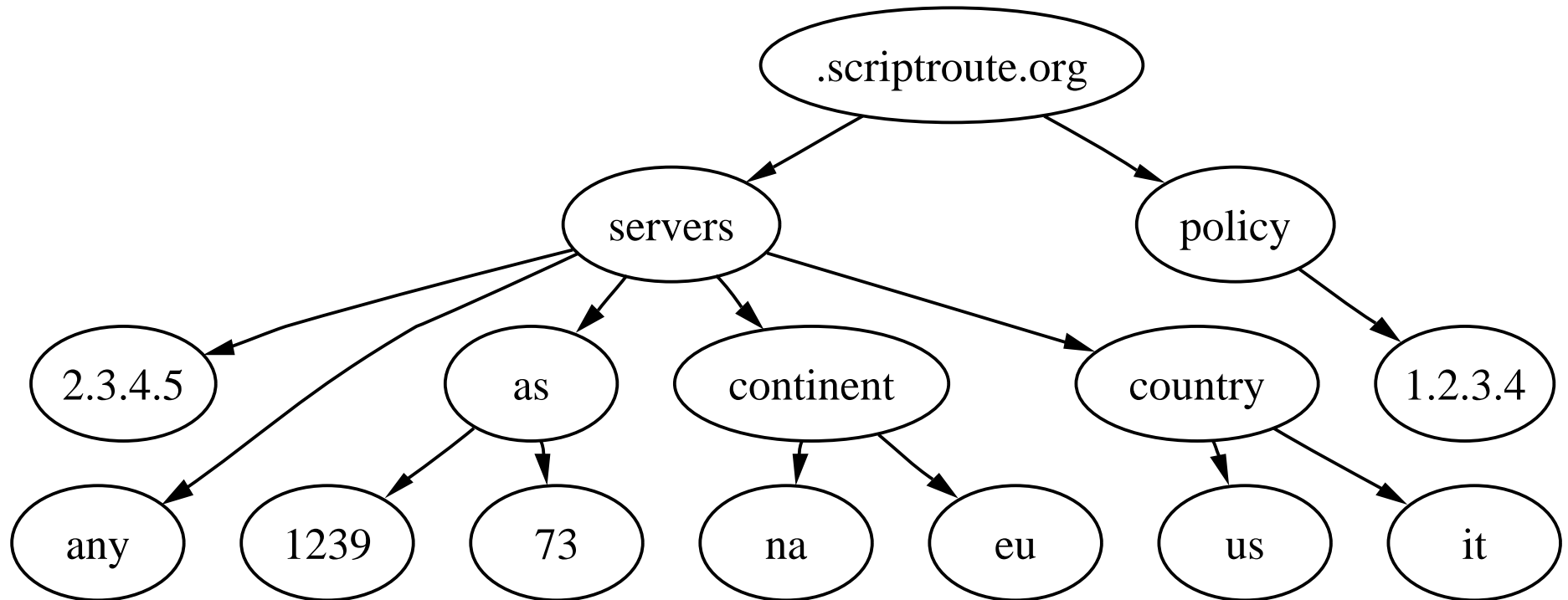

servers listed by AS, continent, country, randomly.

policy destination-specific filters to block traffic.

Conclusion

Scriptroute distributed lightweight measurement

Flexible: Remotely executed scripts.

Safe: Limit script behavior.

Open: Unauthenticated users, arbitrary servers.

Local control: Admins control limits, packets.

One system: Servers listed in DNS, easy distributed measurements.

Alpha deployment on PlanetLab (www.planet-lab.org).

For information, source, and packages:

www.scriptroute.org